

0.5mm Pitch
SERIES

6214

0.5mmピッチ ストレート SMT 片面接点 スライドロック
0.5mmPitch Vertical SMT Single-sided contact Slide lock

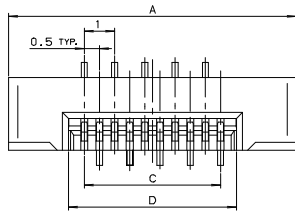

標準タイプ Standard Slider

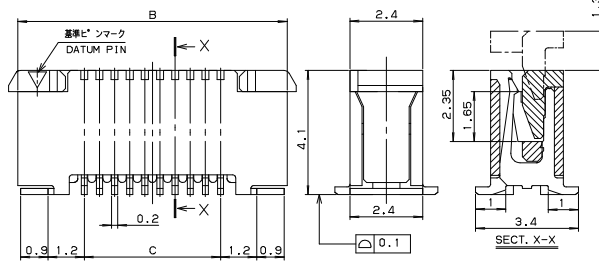

極数 NO. OF POS.	A	B	C	D
6	7.5	6.9	2.5	3.6
7	8.0	7.4	3.0	4.1
8	8.5	7.9	3.5	4.6
9	9.0	8.4	4.0	5.1
10	9.5	8.9	4.5	5.6
11	10.0	9.4	5.0	6.1
12	10.5	9.9	5.5	6.6
13	11.0	10.4	6.0	7.1
14	11.5	10.9	6.5	7.6
15	12.0	11.4	7.0	8.1
16	12.5	11.9	7.5	8.6
17	13.0	12.4	8.0	9.1
18	13.5	12.9	8.5	9.6
19	14.0	13.4	9.0	10.1
20	14.5	13.9	9.5	10.6
21	15.0	14.4	10.0	11.1
22	15.5	14.9	10.5	11.6
23	16.0	15.4	11.0	12.1
24	16.5	15.9	11.5	12.6
25	17.0	16.4	12.0	13.1
26	17.5	16.9	12.5	13.6
27	18.0	17.4	13.0	14.1
28	18.5	17.9	13.5	14.6
29	19.0	18.4	14.0	15.1
30	19.5	18.9	14.5	15.6

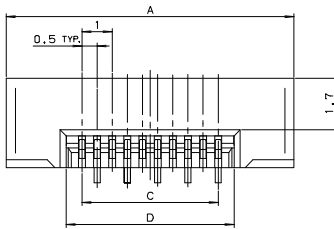

スライダー拡張タイプ Extended Slider

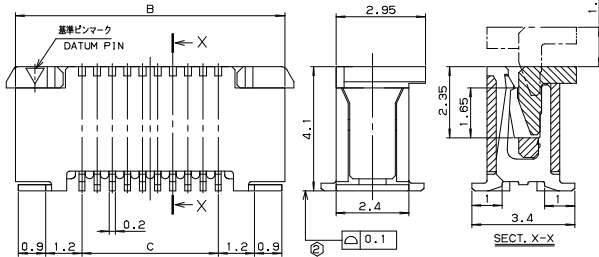

極数 NO. OF POS.	A	B	C	D
6	7.5	6.9	2.5	3.6
7	8.0	7.4	3.0	4.1
8	8.5	7.9	3.5	4.6
9	9.0	8.4	4.0	5.1
10	9.5	8.9	4.5	5.6
11	10.0	9.4	5.0	6.1
12	10.5	9.9	5.5	6.6
13	11.0	10.4	6.0	7.1
14	11.5	10.9	6.5	7.6
15	12.0	11.4	7.0	8.1
16	12.5	11.9	7.5	8.6
17	13.0	12.4	8.0	9.1
18	13.5	12.9	8.5	9.6
19	14.0	13.4	9.0	10.1
20	14.5	13.9	9.5	10.6
21	15.0	14.4	10.0	11.1
22	15.5	14.9	10.5	11.6
23	16.0	15.4	11.0	12.1
24	16.5	15.9	11.5	12.6
25	17.0	16.4	12.0	13.1
26	17.5	16.9	12.5	13.6
27	18.0	17.4	13.0	14.1
28	18.5	17.9	13.5	14.6
29	19.0	18.4	14.0	15.1
30	19.5	18.9	14.5	15.6

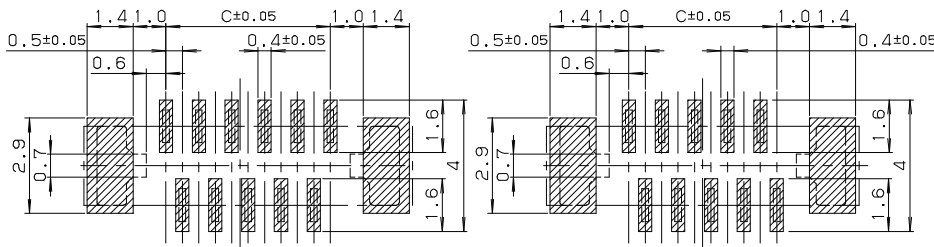

基板取付寸法 (奇数ピン)

MOUNTING LAYOUT (ODD PIN)

基板取付寸法 (偶数ピン)

MOUNTING LAYOUT (EVEN PIN)

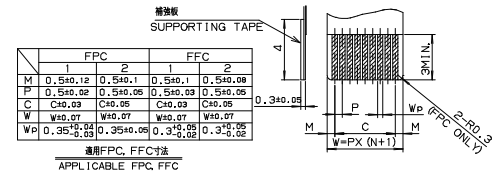

	1	2	1	2
M	0.5±0.12	0.5±0.1	0.5±0.1	0.5±0.08
P	0.5±0.02	0.5±0.06	0.5±0.03	0.5±0.05
C	C±0.03	C±0.05	C±0.03	C±0.05
W	W±0.07	W±0.07	W±0.07	W±0.07
Wp	0.35±0.03	0.35±0.05	0.3±0.02	0.3±0.05

適用FPC, FFC寸法
APPLICABLE FPC, FFC

注文コード ORDERING CODE

04 6214 0XX XXX XXX+

RoHS 対応品

RoHS Compliant Product

800+: スズ銅めっき Sn-Cu Plated
846+: 金めっき Au Plated

000: 標準タイプ Standard Slider

010: スライダー拡張タイプ Extended Slider

極数 NUMBER OF POSITIONS

生産対応可能極数については、営業部に
ご確認願います。

Feel free to contact our sales department
for available numbers of positions.

0.5mm Pitch
SERIES

6214

エンボス梱包品
Tape and Reel Package

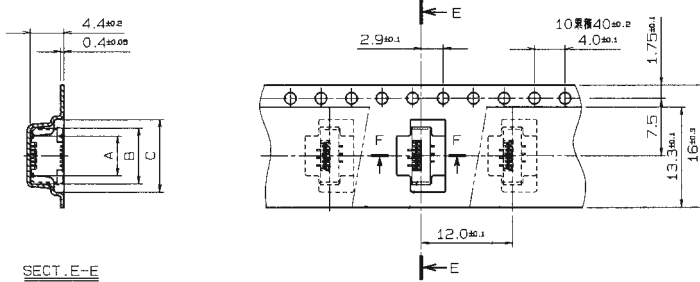

SECT. E-E

寸法表 DIMENSION				
極数 NO. OF POS.	型番	A	B	C
6	04 6214 006 XXX XXX+	5.2	7.3	9.5
7	04 6214 007 XXX XXX+	5.7	7.8	10.0
8	04 6214 008 XXX XXX+	6.2	8.3	10.5

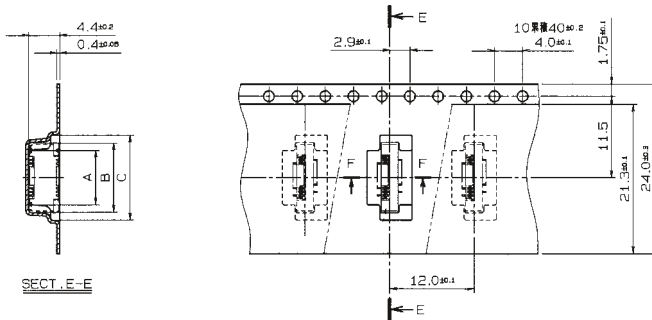

SECT. E-E

寸法表 DIMENSION				
極数 NO. OF POS.	型番	A	B	C
9	04 6214 009 XXX XXX+	6.7	8.8	11.0
10	010	7.2	9.3	11.5
11	011	7.7	9.8	12.0
12	012	8.2	10.3	12.5
13	013	8.7	10.8	13.0
14	014	9.2	11.3	13.5
15	015	9.7	11.8	14.0
16	016	10.2	12.3	14.5
17	017	10.7	12.8	15.0
18	018	11.2	13.3	15.5
19	019	11.7	13.8	16.0
20	020	12.2	14.3	16.5
21	021	12.7	14.8	17.0
22	022	13.2	15.3	17.5
23	023	13.7	15.8	18.0
24	04 6214 024 XXX XXX+	14.2	16.3	18.5

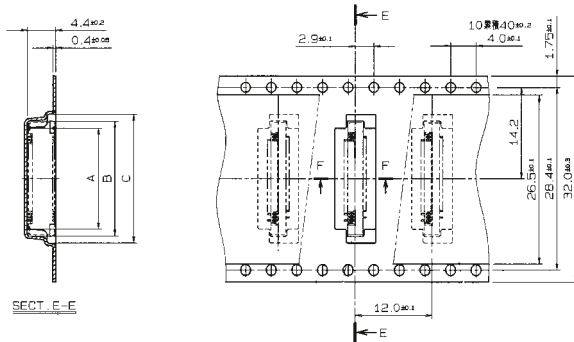

SECT. E-E

寸法表 DIMENSION				
極数 NO. OF POS.	型番	A	B	C
25	04 6214 025 XXX XXX+	14.7	16.8	19.0
26	026	15.2	17.3	19.5
27	027	15.7	17.8	20.0
28	028	16.2	18.3	20.5
29	029	16.7	18.8	21.0
30	04 6214 030 XXX XXX+	17.2	19.3	21.5

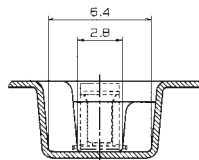

SECT. F-F

注文コード ORDERING CODE
04 6214 0XX XXX XXX+

RoHS 対応品
RoHS Compliant Product

800+ : スズ銅めっき Sn-Cu Plated
846+ : 金めっき Au Plated

000 : 標準タイプ Standard Slider
010 : スライダー拡張タイプ Extended Slider

極数 NUMBER OF POSITIONS

生産対応可能極数については、営業部にご確認願います。

Feel free to contact our sales department for available numbers of positions.

梱包数量 1000個/リール
PACKING QUANTITY : 1000/Reel